

STRENGTH AND DEFORMATION BEHAVIOR IN STEEL FIBRE REINFORCED NORMAL CONCRETE BY OPTICAL (ESPI) METHODS

Timothy NYOMBOI^{*1}, Hiroshi MATSUDA^{*2}, Tsutomu YAMASHITA^{*3}, Tomohiro OHARA^{*4}

ABSTRACT

Structural application of Steel Fibre Reinforced Concrete (SFRC) requires in-depth evaluation of its strength and performance. Influence of steel fibre on concrete material properties and deformation is better understood under full field measurements by optical method. This study therefore clarifies the material characteristics and deformations of SFRC based on Electronic Speckle Pattern Interferometry (ESPI) and conventional methods. SFRC was found to be superior in shear, tensile and deformation capacity, with no improvement in compressive strength. ESPI yielded more detailed and better results.

Key words: Steel fibre reinforced concrete, Strength, Electronic Speckle Pattern Interferometer, Full field optical method

1. INTRODUCTION

Inclusion of steel fibres in concrete offers a convenient and practical means of achieving improvements in engineering properties of concrete. Plain concrete is brittle while steel fibre reinforced concrete (SFRC) is a homogenous ductile composite product. Steel fibres in concrete is expected to enhance the post cracking tensile strength of the composite and its fracture energy [1-2]. This could be attributed to the even and random distribution of fibres throughout the volume of concrete at much closer spacing than conventional reinforcements. As a result, enhanced capacity in crack control, fracture toughness, ductility, energy absorption and tensile strengths in SFRC can be realized. SFRC has been widely used as reinforcements for industrial floors, shotcrete for tunnels and pipe repair [3]. Structural application in shear failure control is still not clarified. Furthermore, limitations in traditional measurement methods hinder the full potential of quantifying and understanding the behavior of the material under deformations. Accurate measurement of surface deformations is much significant in clarifying the governing mechanism of mechanical phenomenon in concrete [4]. Understanding of the aforementioned beneficial material properties and behavior in SFRC therefore requires advanced measurement techniques such as optical methods.

In conventional methods, strain measurement is at a point and it depends on stability of the gauges during the deformation of the specimen. Furthermore, definite identification of the actual cracking stage and regions of high deformations is difficult in the

conventional approach. The latter approach is only possible after the specimens have physically failed. However, a full-field optical method offers the possibility of capturing these deformations real time. The merit of this method is that final results can be compared with those from finite element analysis models [5]. Principles and theoretical background of the optical method have been given in details in [6].

The objective of the present study is to clarify the material property characteristics and deformation behavior in steel fibre reinforced concrete (SFRC) by optical full field methods. Two dimensional optical full -field ESPI was used to measure displacements, strains and capture the deformation patterns in steel fibre concrete beams and cylinders in conjunction with the conventional methods. The results obtained showed that SFRC is superior in shear, tensile and deformation capacity in comparison with normal concrete. However, there was no improvement in the compressive strength. Failure pattern obtained by ESPI method was found to be in agreement with physical failure pattern observed during the test. Generally, ESPI yielded detailed and better results in comparison with the conventional method

2. TEST PROGRAMS

2.1 Materials

(1) Fibre Concrete

Normal concrete with an average strength of 38MPa was made from standard ordinary Portland cement and aggregates meeting the JSCE guidelines for Concrete [7]. It was variably (0.5, 1.0 and 1.5%)

*1 Graduate School of Science and Technology, Nagasaki University, M.Phil Eng, JCI Member

*2 Prof., Graduate School, Dept. of Structural Engineering, Nagasaki University, Dr. Eng., JCI Member

*3 Dept. of Structural Engineering, Nagasaki University, JCI Member

*4 Dept. of Structural Engineering, Nagasaki University, JCI Member

reinforced with end hooked discrete steel fibres (Fig.1). In order to achieve a workable mix, 0.8% of an AE water reducing admixture (POZOLIS15L) was used to improve the flow without increasing the water content. The mix design was carefully designed to ensure that at least the percentage of fines was more than 40% of the total aggregates. Variable mix proportions were used according to the fibre content as shown in Table 1. In effect the steel fibres became part of the mix ingredients and hence substitutes part of the aggregates.



Fig.1 Collated end hooked steel fibre

Table 1 Mix proportions

Fibre content %	Kg/m ³				
	Water	Cement	Gravel	Sand	AE
0	171	377	938	712	3
0.5	171	377	930	707	3
1	171	377	923	700	3
1.5	171	377	916	695	3

(2) Reinforcements

In addition to the steel fibres, 6mm diameter deformed rebars were used in the beams to reduce the influence of flexural deformations. The steel fibres were 0.62mm in diameter and 30mm in length giving an aspect ratio of 48.4. The properties of these reinforcements are given in Table 2.

Table 2 Characteristics of reinforcements

Type	Elastic Modulus (kN/mm ²)	Tensile strength (MPa)	Remark
fibres	210	1000	End hooked
Re bars	210	340	Deformed

2.2 Test set up and procedure

The tests specimens consisted of six 400×100 × 100mm beams and twelve number cylinders of 200mm diameter by 200mm height made from plain and steel fibre reinforced concrete. All the specimens were cured under water for period of 28 days before to testing. Continuous curing under complete immersion was done in order to maximize the concrete strength gain and improve bonding with the fibres. Tests on the beam and the tensile strength specimens were done using a 300kN capacity universal testing machine. Controlled loading was applied on the specimens while the full-field strains and displacements were monitored and recorded using a set of optical measurements equipment system (ESPI) comprising a desk top computer and CCD camera (2D sensor type). In addition to the universal testing machine, a data logger and laptop for control and recording of loads and

conventional strains were used. The complete set up was as shown in Fig.2. Conventional strains and displacements were measured using normal strain gauges and Linear Variable Differential Transformer (LVDT) displacement probe on the split and flexural test specimens, respectively.

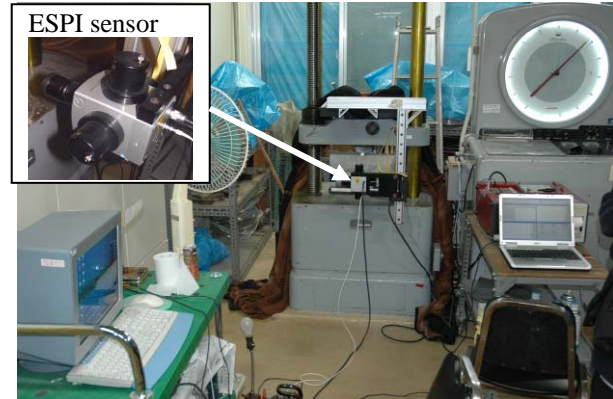
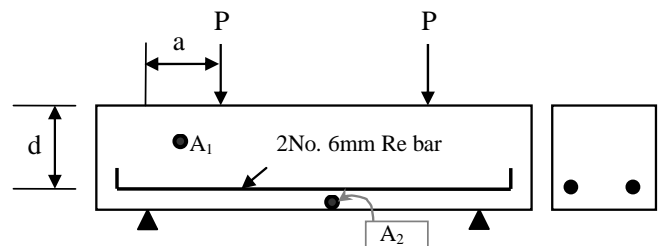
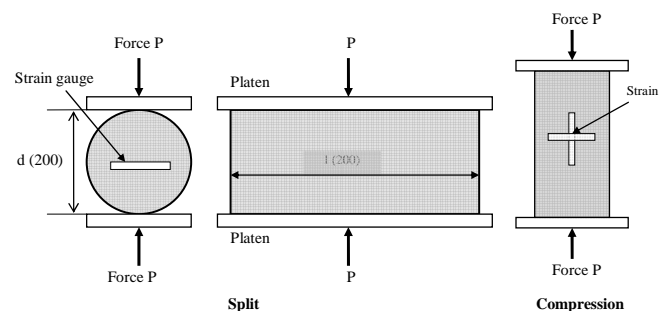

Fig.2 Optical and Normal test set up



(a) Flexure (Indirect shear)



(b) Split and Compression

Fig.3 loading arrangement

Compression test were undertaken using a 600kN universal test machine, while the strains were measured using strain gauges. In order for shear failure to occur, a shear span a of 82mm and depth d of 82mm was adopted (Fig.3a). This corresponds to a shear span to depth ratio of 1. Selected ESPI strain and displacement data were obtained at points A_1 and A_2 respectively as shown in Fig.3a.

Specimens for ESPI measurement had the target surfaces sprayed with special white (UNI Glo) paint to create a reflective surface in order to obtain a better

contrast in the captured images during loading. The loading arrangement for the beams and cylinders was as shown in Fig.3 (a) and (b).

3. RESULTS AND DISCUSSION

3.1 Average material properties

Table 3 shows the summary of the average material properties obtained from the split and compressive tests respectively. There is an increase in the ultimate tensile strength in the case of 1 and 1.5% fibre reinforced specimens with no improvements in the compressive strengths for all the fibre reinforced specimens. Generally there is gradual increase in the Elastic modulus but with no significant change on the Poisson ratio.

Table 3 Average material properties

Fibre %	Compressive (N/mm ²)	Tensile (N/mm ²)	Poisson ratio	E N/mm ²
0	45.07	3.67	0.18	31108
0.5	37.68	3.37	0.19	46517
1	42.40	4.40	0.22	54504
1.5	37.82	4.86	0.19	54766

3.2 Compressive Strength

Although Influence of steel fibres on compressive strength was found to be minimal, there is generally an improvement in stiffness in the initial stages particularly in the fibre reinforced specimens results. As a result the secant Modulus is also observed to have also increased accordingly.

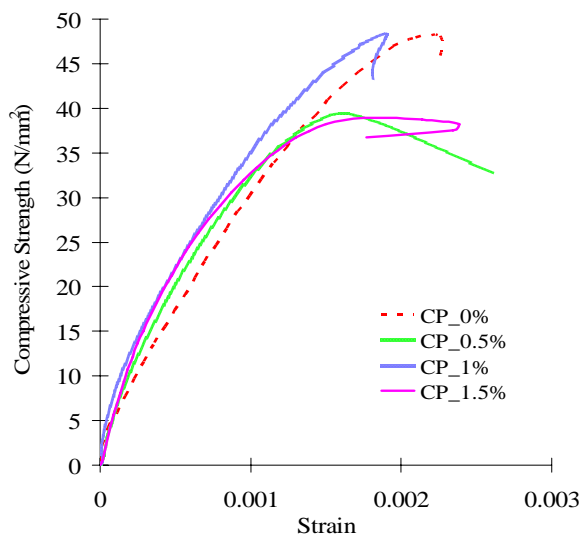

Fig.6 Compression strength

Decrease in the ultimate compressive strength was observed to occur in SP0.5 and SP1.5% specimens as depicted in Fig. 6.

Under compressive loads, fibres cause crack-closing forces induced by transverse tension forces resulting in an increase in strength, however existence of porosity due to inclusion of steel fibres in concrete mix have the tendency to cancel the former [8].

The results of the compression test are in agreement with this argument. Because of the cylindrical shape of the specimens, two dimensional ESPI measurements were not undertaken. Three dimensional optical systems could be a best suit this kind of specimen.

3.3 Tension strength and deformation

The main parameters that characterized the strength and deformation behavior of the S.F.R.C were the tensile strength and ductility. Fig.4 shows the tensile strength results as obtained by Electronic speckle pattern interferometry (ESPI), while results based on the conventional methods are as shown in Fig 5. Generally, the tensile strength and ductility increases in tandem with the increase in steel fibre content present in the concrete. However, clarity in the influence of the steel fibres is more predominant throughout the results in the case of concrete with 1.5% fibre content. An average increase of approximately 32% in ultimate tensile strength is realized in the latter case (Table 3). There is generally improvement in both tensile strength and ductility in the case of specimens with 0.5% and 1% fibre content. This superiority is important in fracture control in concrete as fibres tend to reduce cracks and soften the deformation behavior by redistributing the tension stress.

Detailed deformation patterns could also be obtained in the case of ESPI measurements as shown in Fig.4 (a) and (c). Fig.4 (a) 1 and 2 shows ESPI deformation strain pattern images at the ultimate load in SP1.5% and SP0% specimens, while Fig. 4 (c) shows the ultimate strain behavior across the center face of the split specimen. It is observed in these figures that it is within the mid face of the specimens where cracks occurred and that there exists an increase in deformation as in comparison to other regions. Localized strain behavior as shown in Fig.4 (c) can give an indication of the fibre influence and distribution in the concrete. The strains in SP0.5% are higher in comparison to those of SP 1.5% and SP1%. This could be as a result of an optimum distribution of steel fibres in the concrete especially within the cracked region. Generally, it is observed that all the fibre reinforced specimens (SP0.5, SP1 and SP1.5%) had an increased strain capacity at mid face where cracks were observed as compared with specimens without fibres (SP0%). Higher fiber content leads to increased stress redistribution and thus a reducing strain level occurs as observed in SP 1% and SP1.5%. Concrete is a brittle material, and thus as expected, minimal strain is observed in SP0%.

Influence of strain gauge stability after failure can be observed in the conventional measurements results as seen in Fig 5. Beside the specimens with 1.5% fibre content, other results showed instability after failure. This is a common phenomenon observed when delaminating or breakage of the strain gauge occurs during measurement.

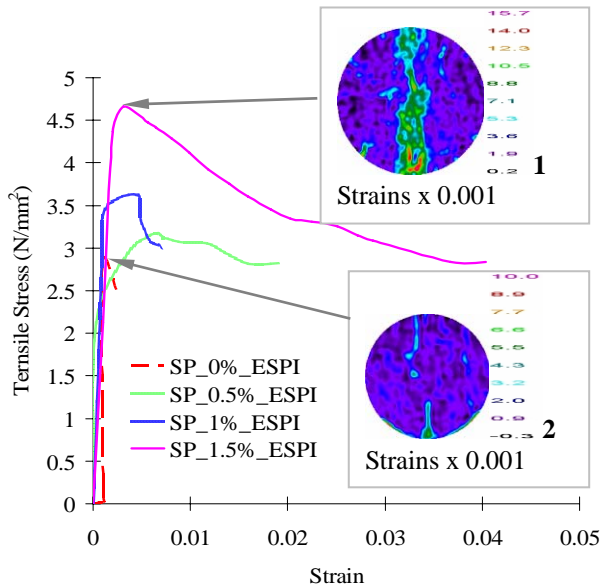

(a) Tensile strength and full field ultimate deformation pattern

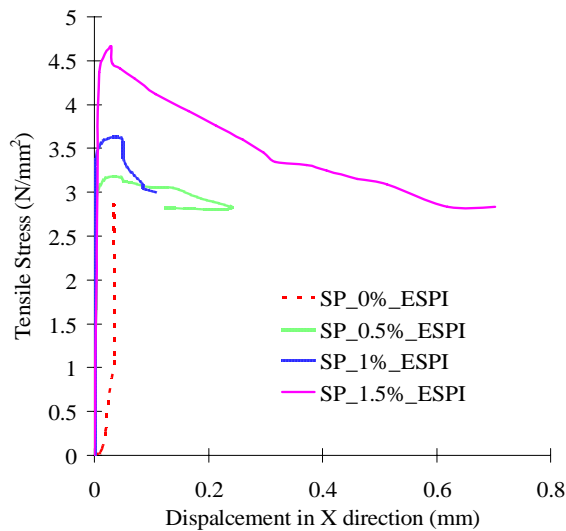

(b) Tensile Stress-Displacement

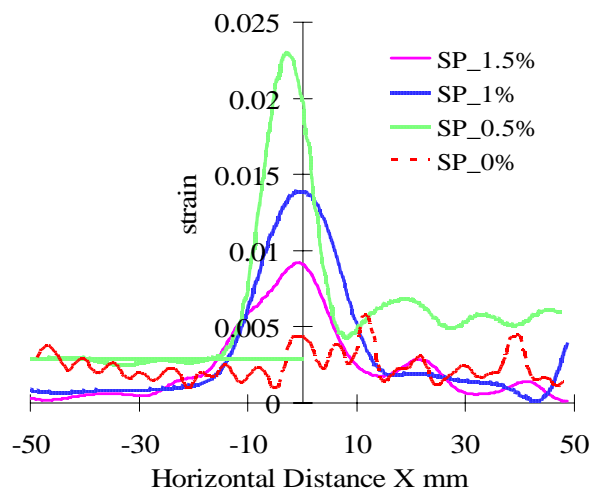

(c) Ultimate deformation profile across centre face

Fig.4 ESPI deformation Measurements

In materials such as steel fibre reinforced concrete where post tensile strength and ductility is required to be evaluated, reliable measurement technologies such as optical methods is therefore of advantageous method.

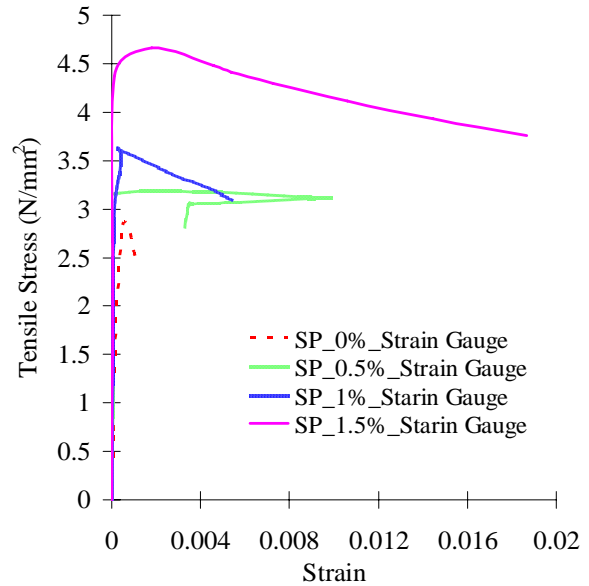

Fig. 5 Conventional Stress-strain measurements

3.4 Shear deformation and strength

It is normally in reinforced concrete beams and slabs that shear phenomenon is commonly observed and more so considered in design. In this research pure shear test was not used but rather an indirect method of four point testing was adopted based on a parallel on going research on shear. Shear strains and displacement measurements were obtained based on ESPI method, however additional displacement measurements were taken using the conventional LVDT probe. The results on shear phenomenon where steel fibres were used are thus reported here in brief. Shear failure in concrete is known to be brittle and catastrophic. This problem in part can be reduced with the use of ductile material such as steel fibre reinforced concrete (S.F.R.C). Fig.7 and 8 indicates that steel fibre concrete has a higher shear capacity compared with plain concrete. All the fibre reinforced specimens showed improved post-yield shear strength as compared with those without fibres. An approximately 59% increase in ultimate strength is achieved in beam specimens reinforced with 1.5% steel fibres (FB1.5% in Fig.7 and 8). Similarly ductile behavior is observed in all the specimens reinforced with steel fibres. Significant ductility is realized in shear when higher fibre content is used, as demonstrated by specimens having a fibre content of 1.5%. Furthermore, crack development and propagation was monitored and recorded with the use of ESPI as seen in the captured images at ultimate stage of shear failure (Fig.7), similar to those captured for the split test (Fig. 4 (a) 1 and 2).

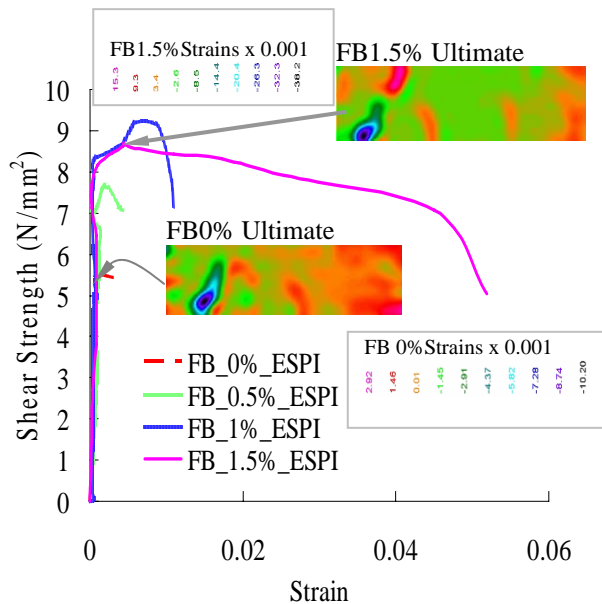
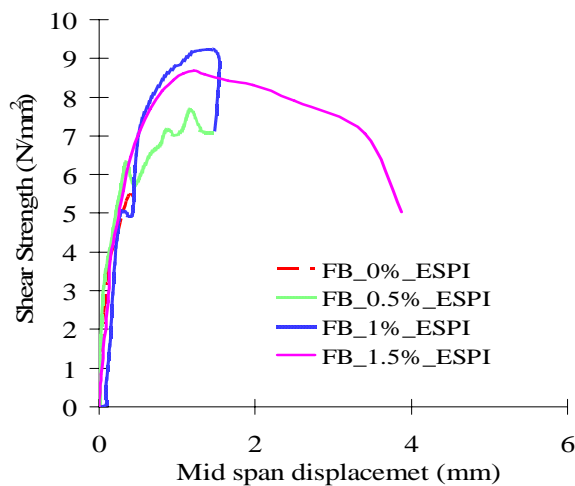
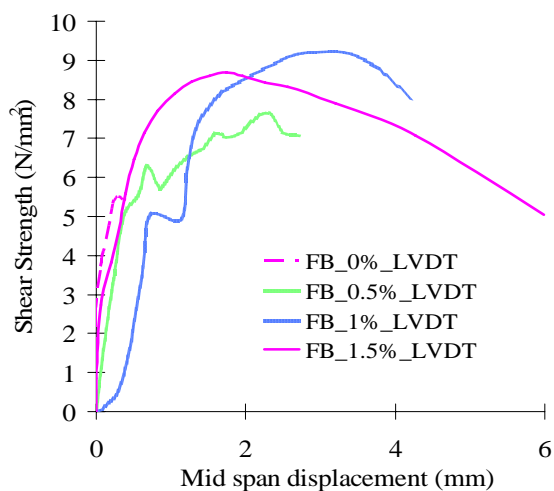

Fig 7 Shear strength-strain relationship and deformation Behavior



(a) ESPI measurements



(b) LVDT Measurement

Fig.8 Shear strength-mid span Displacement

All ESPI deformation measurement results showed similar stress-displacement development

pattern before yielding. However, on yielding only specimens with higher fibre content (FB1 and FB1.5%) maintained the trend with divergence just before ultimate failure (Fig.8a). Pre yielding behavior in the conventional LVDT measurement results showed slight variability in FB0%, FB0.5 and FB1.5% (Fig.8b). However, significant difference is noticed throughout, in FB1% results. In both ESPI and LVDT results a slight stress relaxation is observed to occur immediately after yielding in the fibre specimens. This is the consequence of shear softening on occurrence of initial crack. This initial failure is immediately resisted by the steel fibres through crack bridging and stress transfer. As a result a recovery in the strength is achieved thereafter.

ESPI ultimate displacement in all the fibre specimens is about 1.2mm. On the other hand LVDT results showed variable ultimate displacement values of 2.3, 3.1 and 1.8mm for FB0.5, FB1 and FB1.5% respectively. In FB1.5% specimens, the maximum displacement value achieved is 3.8 and 5.9mm in ESPI and LVDT respectively. Generally, the conventional displacement results are higher than those from ESPI. Full field (ESPI) displacement measurement were based on the actual specimen point deformation, while LVDT measured data were obtained at an eccentric point from the beam (use of an angle bracket) as necessitated by technical logistics normally encountered in taking such measurements. This explains the differences observed between the ESPI and LVDT measurements results.

4. CONCLUSIONS

- (1) Reduced ultimate compressive strength is observed in steel fibre reinforced concrete.
- (2) Steel fibres improve post yielding deformation properties in concrete. Ductility, tensile and shear strengths are significantly enhanced.
- (3) Deformation and associative parameters can be measured and monitored accurately with ESPI method
- (4) Steel fibre concrete was successfully produced using normal standard materials, with fine aggregate content kept at approximately 43% of the total aggregate content.
- (5) Generally steel fibres were found to reduce the workability of fresh concrete and thus a suitable admixture must be used to control water content.

ACKNOWLEDGEMENT

The authors acknowledge the support from Japan Government Ministry of Education for the research scholarship, Shinko Kenzai, Ltd. for the supply of the steel fibers and BASF Pozzoloth, Ltd. for the supply of the water reducing admixtures agents. Assistance in the production of the concrete and specimens received from Mr T. Shirahama, R. Hirahama, H.Nishida, J.Fukumitsu is highly appreciated

REFERENCES

- [1] Holschemacher, K., et al., "Application of steel fibre Reinforced concrete for Timber – Concrete Composite Constructions", Lacer No. 7, 2002, pp 161-170.
- [2] Shitote, S.M., Shah S.P., "A fracture Mechanics formulation for shear analysis of short steel fibre reinforced concrete beams", 3rd Asia Pacific specialty Conference on Fibre Reinforced Materials, Nov 17-18 2003, Shangai Hunan China, pp 209-220.
- [3] Rossi, P., "Steel fibre reinforced concrete; an example of French Research", Materials Journal, ACI, Vol.91, pp 273-279, May 1994.
- [4] Pallewatta, M.T., et al., "Measurement of surface Displacement Field of Concrete by Laser Speckle method", JCI Concrete Engineering Annual report, Feb 1990, pp 835.
- [5] Tyson, J., Schmidt, T., Galanulis, K., "Advanced Photogrammetry for robust deformations and Strain Measurement", SEM 2002 Annual Conference, Milwaukee,WI, June 2002, pp1-2
- [6] ASCE: Imaging Technologies, techniques and applications in Civil Engineering, Proceedings of the second International conference, Davos 1997, pp 10-19, 217-233
- [7] JSCE: Guidelines for concrete Standard Specification for Concrete structures, Materials and Construction, 2002, pp 76-77
- [8] Kutzing, L. et al., "Design principals for steel fibre Reinforced Concrete-A fracture Mechanics approach", Lacer No. 4, 1999, pp 175-183